

(75X150 – 30”X60”)

(integral collection)

COUVET

collection

mykonos



COUVET

collection





Welcome to a fascinating journey where light and shadow alternate creating a mosaic of colors and shapes.

Bienvenidos a un viaje fascinante donde la luz y las sombras se alternan creando un mosaico de colores y formas.

A few months ago, I had the opportunity to visit the Couvet forest, a magical place where the oldest forest history is preserved. I was amazed at the beauty and sustainability of this forest, that it respects the environment and the local economy, and that it reflects the values that I share. In this forest, light and shadow alternate creating a diverse landscape full of life. I was able to observe the different species of trees, plants and animals that coexist in harmony. I felt part of nature, and I wanted to take a little piece of it home with me. For this reason, I chose the materials that are inspired by that forest, which offer me unique and original textures, with the energy of the wildest nature. Now, every time I see the harmonious colors and delicate tones of my furniture, I feel the stone and wood under my fingers, and I connect with the essence of nature. My materials are of high quality and durability, and allow me to create warm and elegant spaces. I am very happy with my choice, and I recommend that you also try these materials.

I assure you will not regret.

Hace unos meses, tuve la oportunidad de visitar el bosque de Couvet, un lugar mágico donde se conserva la historia forestal más antigua. Me quedé maravillado con la belleza y la sostenibilidad de ese bosque, que respeta el medio ambiente y la economía local, y que refleja los valores que comparto. En ese bosque, la luz y la sombra se alternan creando un paisaje diverso y lleno de vida. Pude observar las diferentes especies de árboles, plantas y animales que conviven en armonía. Me sentí parte de la naturaleza, y quise llevarme un pedacito de ella a mi casa.

Por eso, elegí los materiales que se inspiran en ese bosque, que me ofrecen texturas únicas y originales, con la energía de la naturaleza más salvaje.

Ahora, cada vez que veo los colores armoniosos y los tonos delicados de mis muebles, siento la piedra y la madera bajo mis dedos, y conecto con la esencia de la naturaleza. Mis materiales son de alta calidad y durabilidad, y me permiten crear espacios acogedores y elegantes. Estoy muy contento con mi elección, y te recomiendo que tú también los pruebes.

Te aseguro que no te arrepentirás.

integral collection



Couvet is the solution that comes to cover a wide spectrum of needs, a very versatile series, with a multitude of possibilities, in which we have thought so that the different materials can be combined with each other.

Couvet has a well-studied range of colors with soft, warm gray tones, with different finishes of the material depending on the use for which it is intended; all chosen so as not to fall into monotony.

Couvet es la solución que viene para cubrir un gran espectro de necesidades, una serie muy versátil, con multitud de posibilidades, en la que hemos pensado para que los distintos materiales se puedan combinar entre ellos.

Couvet dispone de una gama de colores muy estudiada con tonos grises, suaves cálidos, con diferentes acabados del material según el uso al que vaya destinado; todo elegido para no caer en la monotonía.

woods
travertines
marbles
stones
concretes

maderas
travertinos
mármoles
piedras
cementos



The Couvet collection will provide you with solutions that are in tune with the most current placement systems on the market. Thanks to the wide range of special pieces, your challenges will be solved in any indoor, outdoor, humid environment...

La colección Couvet te aportará soluciones que están en sintonía con los sistemas más actuales de colocación que existen en el mercado. Gracias a la amplia gama de piezas especiales tus retos quedarán resueltos en cualquier ambiente interior, exterior, húmedo...



floor tiles
wall tiles
facade
pool

pavimento
revestimiento
fachada
piscina

versatile

(75X150 — 30"X60")

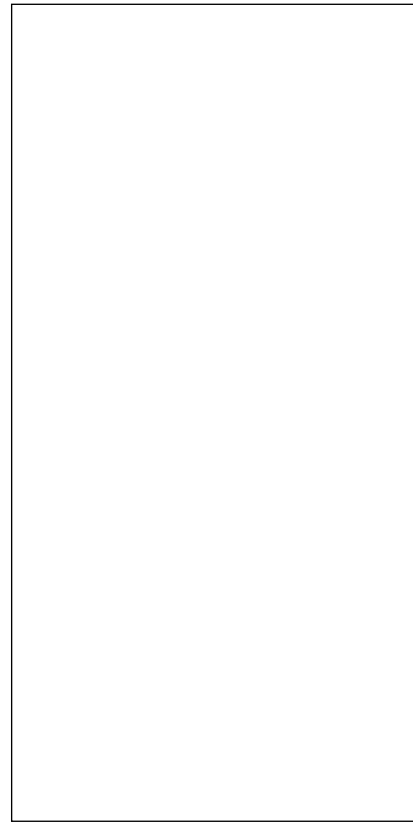

75x150 | 30"x60"

With our base format we are committed to the future, a large size in line with new trends. Easy to place, discreet and allows different finishes.

Con nuestro formato base apostamos por el futuro, un gran tamaño acorde con las nuevas tendencias. Fácil de colocar, discreto y que permite distintos acabados.

advantages ventajas

- User-friendly format.
 - Adequate weight to be able to manage with a single person.
 - Minimalist results, with few joints.
-
- *Formato de fácil manejo.*
 - *Peso adecuado para poder gestionar con una sola persona.*
 - *Resultados minimalistas, con pocas juntas.*

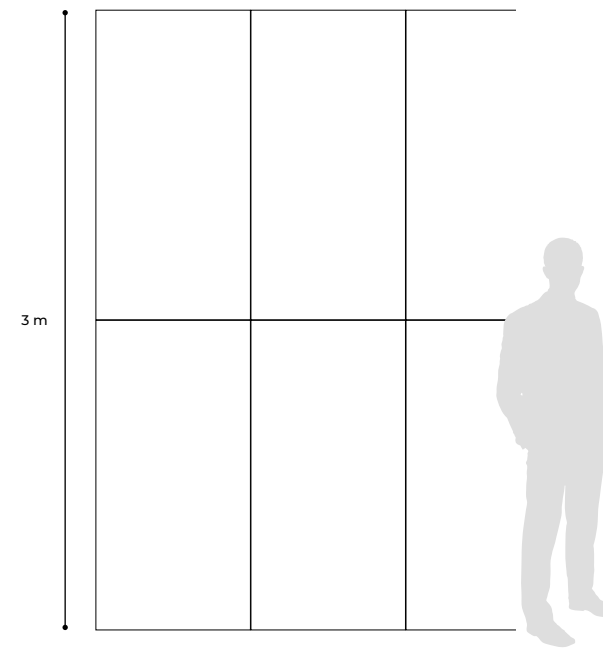

Assembly example with 2 pieces.
Ejemplo de montaje con 2 piezas.



3-piece horizontal mounting. Montaje de 3 piezas en horizontal.

integral collection

The COUVET collection is made up of a set of series that complement each other, achieving a wide variety of combinations of materials that provide novelty and freshness, as well as the particularity of creating endless styles: eclectic, contemporary, formal, minimalist, etc.

La colección COUVET esta formada por un conjunto de series que se complementan entres si, consigueno do una gran variedad de combinaciones de materiales que aportan novedad y frescura, además de la particularidad de conseguir crear un sin fin de estilos, eclécticos, contemporáneos, formales, minimalistas, etc.

(couvet wood)



SFOT HAYA



SFOT ROBLE

(couvet stone)

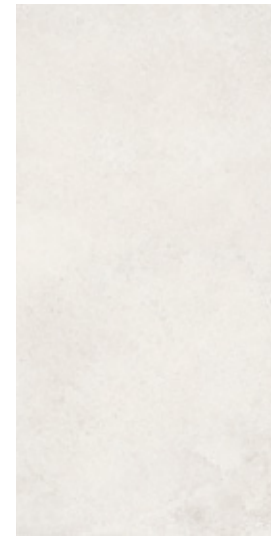

STONE WHITE

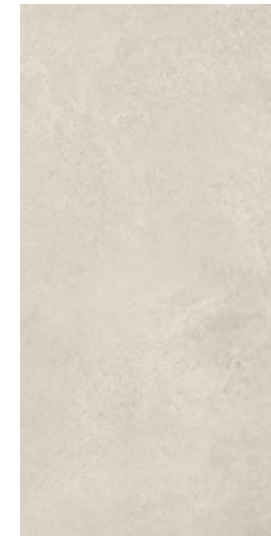

STONE SAND



STONE GREY

(couvet facade)

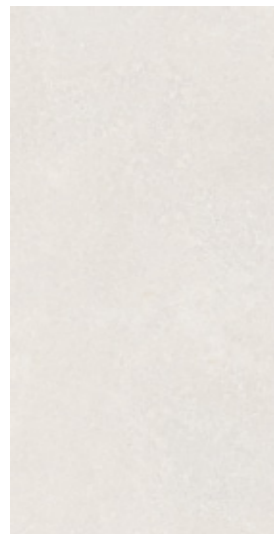

FACADE WHITE

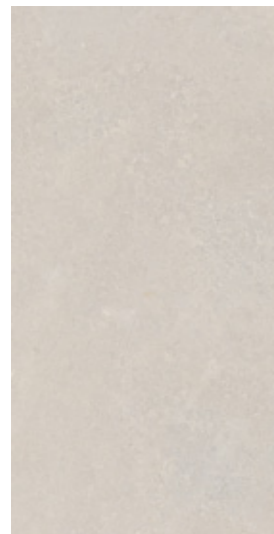

FACADE SAND



FACADE GREY

(couvet marble)

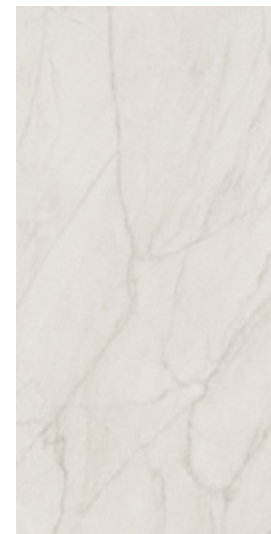

MARBLE

(couvet petra)

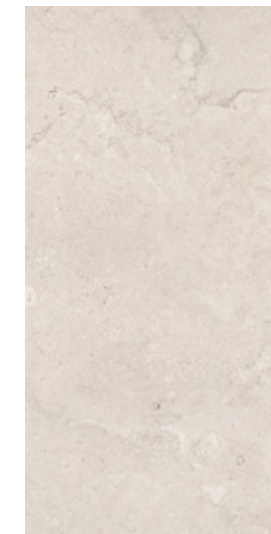

PETRA SAND

(couvet travertino)



TRAVERTINO SAND





COUVET STONE WHITE_75x150 cm | 30"x60"

COUVET PETRA SAND + COUVET WOOD SLAT ROBLE_75x150 cm | 30"x60"





COUVET FACADE SAND + COUVET MIX SLAT_75x150 cm | 30"x60"

COUVET SOFT ROBLE_25x150 | 10"x60" (PV)
COUVET WOOD SLAT ROBLE_75x150 | 30"x60"
COUVET MARBLE_75x150 cm | 30"x60"







COUVET FACADE WHITE + COUVET FACADE GREY_75x150 cm | 30"x60"



COUVET FACADE SAND + COUVET SOFT HAYA + COUVET WOOD MIX SLAT_75x150 cm | 30"x60"







COUVET STONE SAND
 COUVED HAYA SOFT
 COUVET DECO LINES COLOURS
 _75x150 cm | 30"x60"

COUVET MARBLE + COUVET WOOD SOFT ROBLE + COUVET WOOD SLAT ROBLE_75x150 cm | 30"x60"
COUVET MARBLE_75x150 cm | 30"x60 (PV) + (dish shower)



COUVET SOFT HAYA _75x150
cm | 30"x60" (PV)
COUVET PETRA_75x150 cm |
30"x60" (RV) + (dish shower)



COUVET FACADE WHITE + COUVET STRONG ROBLE_75x150 cm | 30"x60"





COUVET FACADE WHITE + COUVET STONE LINE SAND + COUVET SOFT ROBLE
_75x150 cm | 30"x60" (PV)

COUVET STONE WHITE + COUVET STONE GREY + COUVET STONE LINES GREY
_75x150 cm | 30"x60"



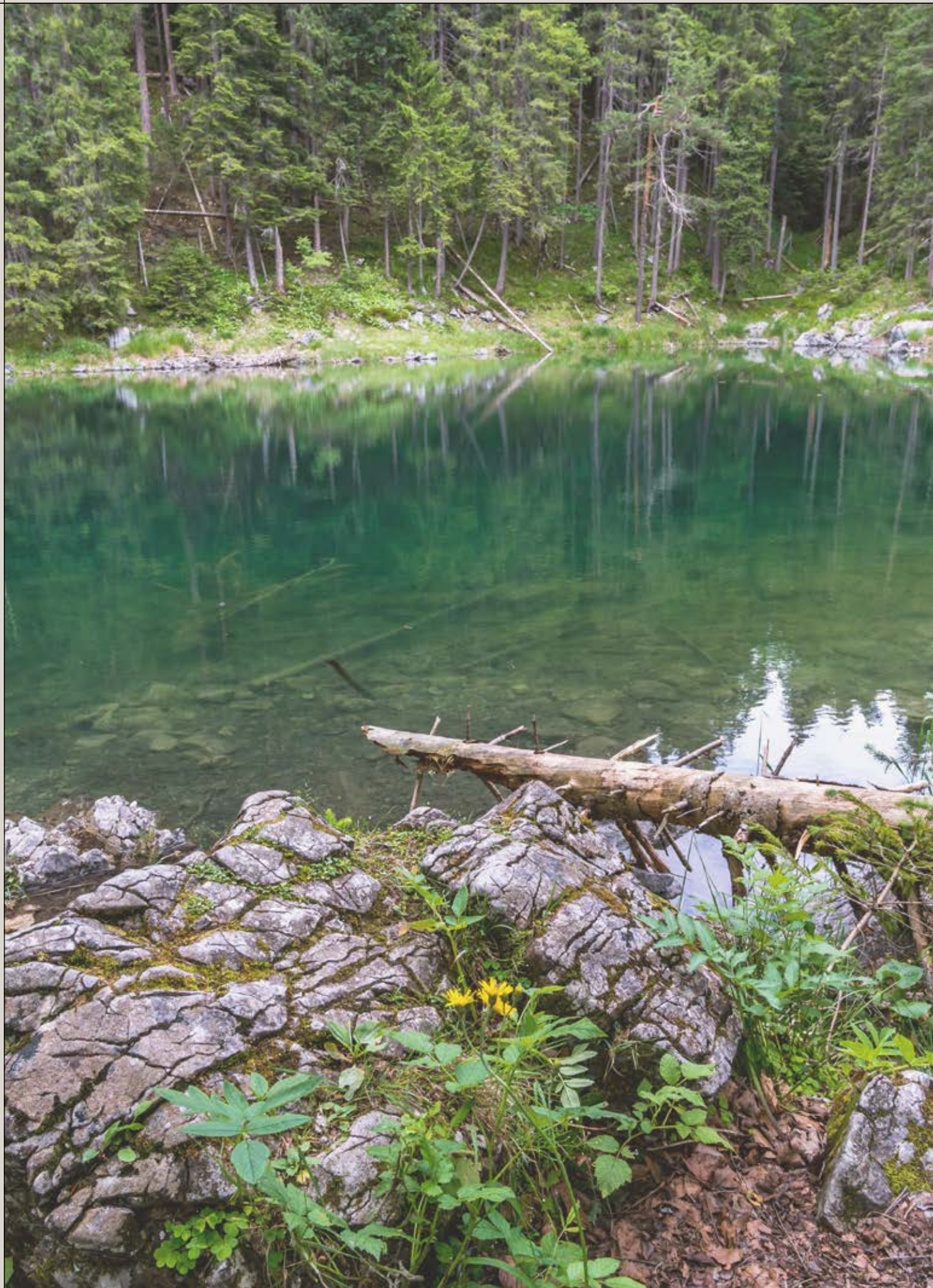

COUVET
collection

technical

(información técnica)

wood

PO   R 

PORCELÁNICO
PAVIMENTO
REVESTIMIENTO
RECTIFICADO
MATE
RELIEVE

PORCELAIN
FLOOR TILE
WALL TILE
RECTIFIED
MATT
RELIEV



COUVET SOFT HAYA



COUVET STRONG HAYA





COUVET ART DECO



COUVET WOOD MIX SLAT
Junta colocación 3mm

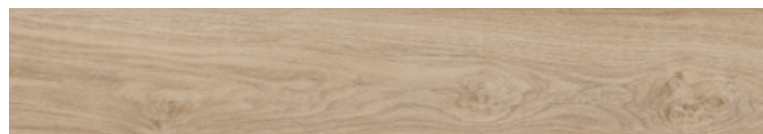

COUVET WOOD SLAT HAYA
Junta colocación 3mm



COUVET SOFT HAYA
C1-C3



COUVET SOFT HAYA



COUVET MEDIUM HAYA



COUVET STRONG HAYA

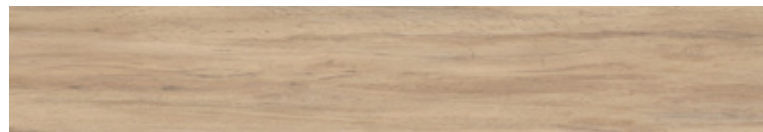

COUVET STRONG HAYA

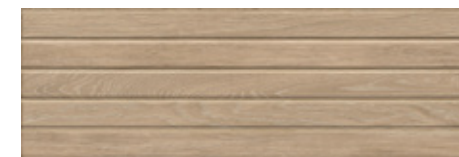

LISTÓN COUVET HAYA





75x150 | 30"x60"



25x150 | 10"x60"

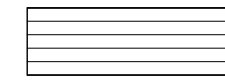

10x60 | 4"x24"



30x90 | 12"x36" 

wood

PO   R 

PORCELÁNICO
PAVIMENTO
REVESTIMIENTO
RECTIFICADO
MATE
RELIEVE

PORCELAIN
FLOOR TILE
WALL TILE
RECTIFIED
MATT
RELIEV



COUVET SOFT ROBLE



COUVET STRONG ROBLE



COUVET ART DECO



COUVET WOOD MIX SLAT
Junta colocación 3mm



COUVET WOOD SLAT ROBLE
Junta colocación 3mm



COUVET SOFT ROBLE
C1-C3



COUVET MEDIUM ROBLE

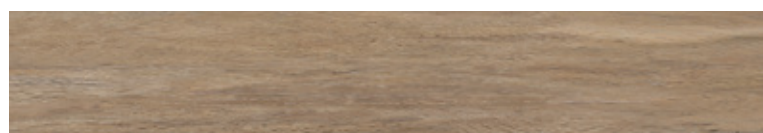

COUVET STRONG ROBLE





COUVET SOFT ROBLE

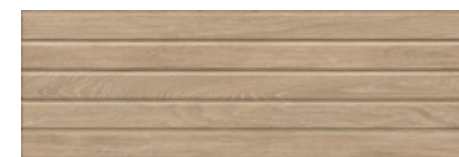

COUVET STRONG ROBLE



LISTÓN COUVET ROBLE



75x150 | 30"x60"



25x150 | 10"x60"

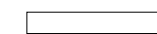

10x60 | 4"x24"

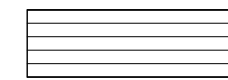

30x90 | 12"x36" 

deco

PO   R 

PORCELÁNICO

PORCELAIN

PAVIMENTO
REVESTIMIENTO

FLOOR TILE
WALL TILE

RECTIFICADO

RECTIFIED



COUVET STONE LINES SAND



COUVET STONE LINES GREY



COUVET DECO LINES COLOURS

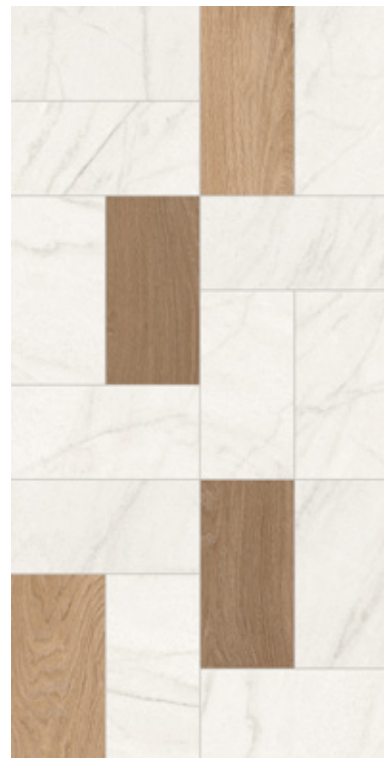

DECO MARBLE



COUVET ART DECO



COUVET WOOD MIX SLAT

COUVET WOOD SLAT MIX +
COUVET SOFT ROBLE_75x150 cm | 30"x60"



COUVET DECO LINES COLOURS_75x150 cm | 30"x60"



stone

petra

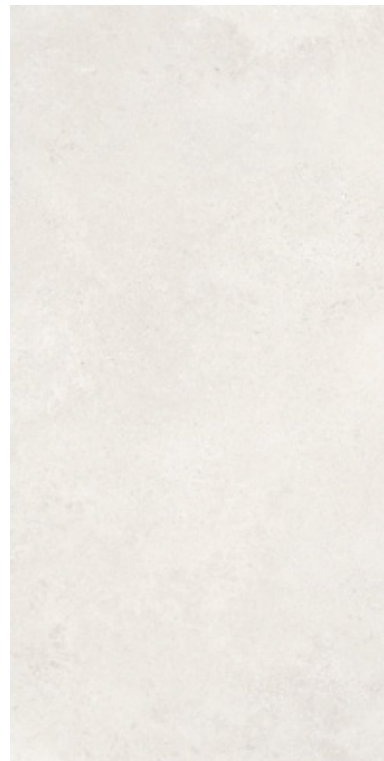

COUVET STONE WHITE



COUVET STONE SAND



COUVET STONE GREY



COUVET PETRA SAND

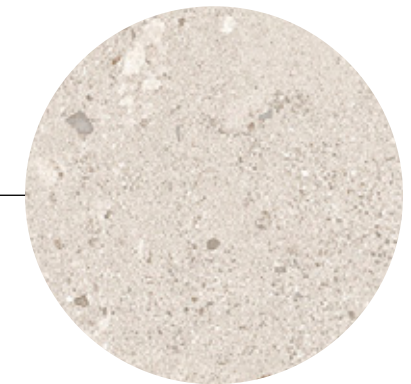

MALLA



MURETO



LOSANGA



75x150 | 30"x60"

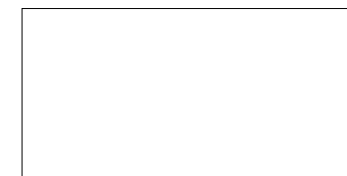

75x150 | 30"x60"



30x30 | 12"x12"



30x30 | 12"x12"



30x30 | 12"x12"

travertino

marble



COUVET TRAVERTINO SAND



COUVET MARBLE



MALLA

MURETO

LOSANGA



MALLA

MURETO

LOSANGA

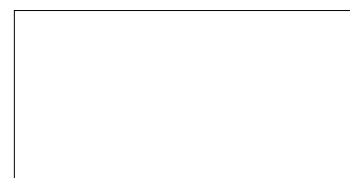

75x150 | 30"x60"



30x30 | 12"x12"



30x30 | 12"x12"



30x30 | 12"x12"



75x150 | 30"x60"



30x30 | 12"x12"



30x30 | 12"x12"



30x30 | 12"x12"



facade

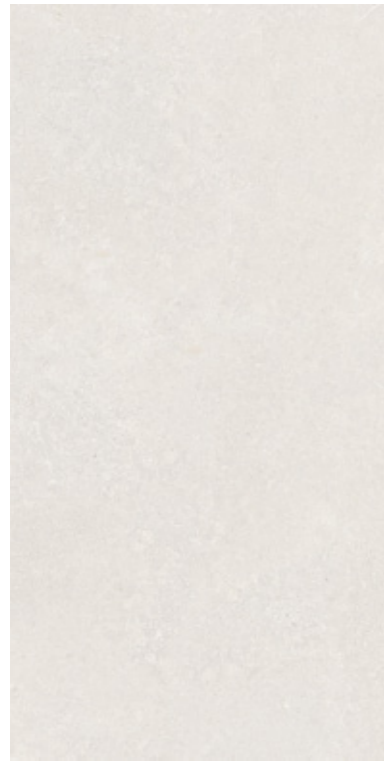

COUVET FACADE WHITE



COUVET FACADE SAND



COUVET FACADE GREY



75x150 | 30"x60"



Projects
carried out
on facades

Proyectos
realizados en
fachadas

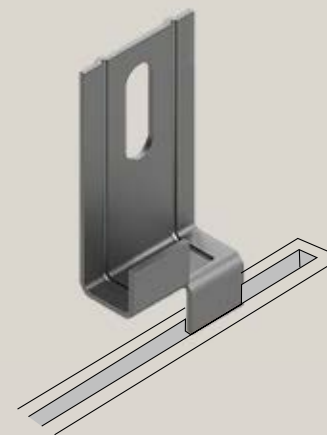

Safety clip for facades with mortared tiles.

Grapa de seguridad para fachadas con azulejo amarterado.

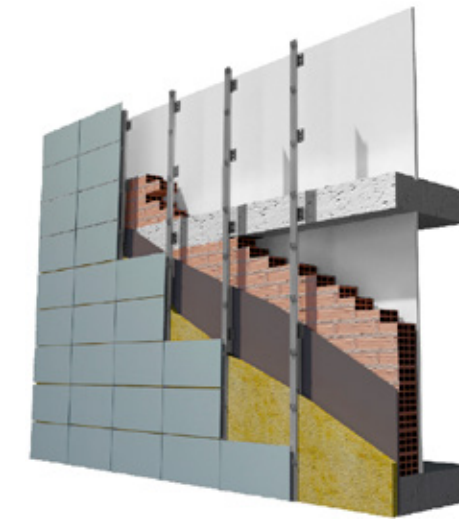

VENTILATED FACADES represent a sustainable and environmentally friendly solution, with innovative advantages in the habitability of spaces.

They represent energy savings of up to 30% by avoiding thermal breakage and establishing a direct barrier of solar radiation on the surface, also prevents internal condensation thanks to the air chamber and eliminates the appearance of humidity. It is also necessary to consider the acoustic reduction towards the interior by 10%.

But without a doubt and most importantly, it means a quick and easy rehabilitation giving a new, more updated and modern life to our buildings.

Las FACHADAS VENTILADAS suponen una solución sostenible y respetuosa con el medio ambiente, con ventajas innovadoras en la habitabilidad de los espacios.

Suponen un ahorro energético de hasta el 30% al evitar los puentes térmicos y establecer una barrera directa de la radiación solar sobre la superficie, asimismo previene condensaciones internas gracias a la cámara de aire y elimina la aparición de humedades. También hay que considerar la reducción acústica hacia el interior en un 10%.

Pero sin lugar a dudas y lo más importante, supone una rehabilitación rápida y sencilla dando una nueva más vida actualizada y moderna de nuestros edificios.

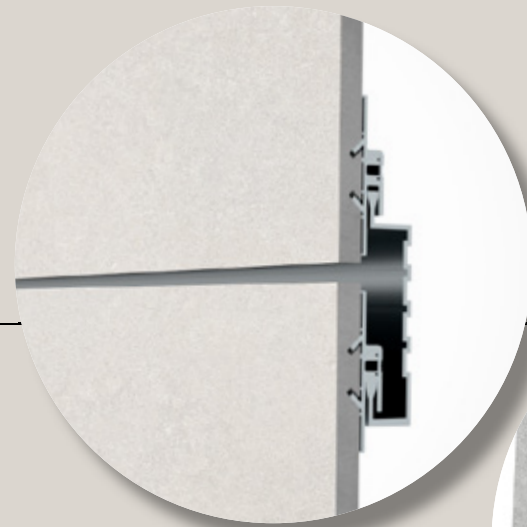

(cat.1+cat.1 slim)

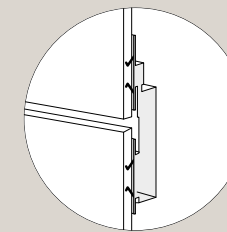

(cat.1+cat.1 slim)

CONCEALED FIXING SYSTEM.

SISTEMA FIJACIÓN OCULTO

The mixed (mechanical and chemical) hidden longitudinal fixing system works with two pairs of grooves on the back of the plate that allow the intersection of profiles.

El sistema de fijación longitudinal oculta mixta (mecánica y química) trabaja con dos pares de ranuras en el dorso de la placa que permiten la inserción de perfiles.

Espesor: 6 mm - 8,5 mm de espesor con malla de refuerzo. 6 mm - 8,5 mm thickness with reinforcement mesh. 8,5 mm - 14 mm de espesor - 8,5 mm - 14 mm thickness. 14 mm - 20 mm de espesor - From 14 mm - 20 mm thickness.



(cat.6+cat.6 slim)

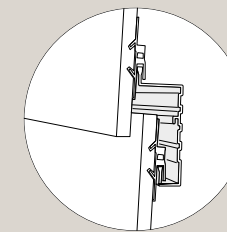

(cat.6+cat.6 slim)

CONCEALED FIXING SYSTEM.

SISTEMA FIJACIÓN OCULTO

The C.A.T 6 system offers a totally innovative finish with the pieces placed obliquely, obtaining a façade in the form of scales. It is a mixed hidden fixing system (mechanical and chemical). It works with a pair of longitudinal grooves on the upper and lower backside. The adhesive is an elastomer adhesive that allows the fixing of the hanger and locking profiles.

El sistema C.A.T 6, ofrece un acabado totalmente innovador con las piezas colocadas en oblicuo, obteniendo una fachada en forma de escamas. Es un sistema de fijación oculta mixta (mecánica y química). Funciona con un par de ranuras longitudinales en el dorso superior e inferior de la placa, y un adhesivo elastómero que permite la fijación de los perfiles de percha y cierre.

Espesor: 6 mm - 8,5 mm de espesor con malla de refuerzo. 6 mm - 8,5 mm thickness with reinforcement mesh. 8,5 mm - 14 mm de espesor - 8,5 mm - 14 mm thickness.

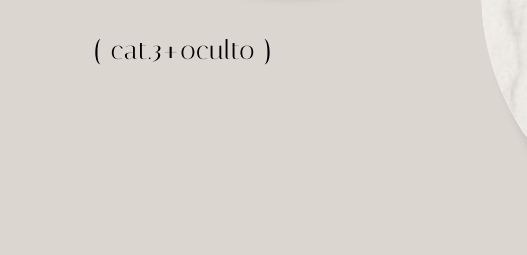

(cat.3+oculto)



(cat.3+visto)

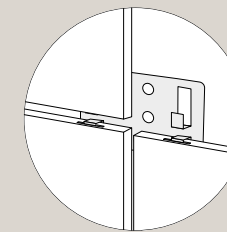

(cat.3+oculto)

CONCEALED FIXING SYSTEM.

SISTEMA FIJACIÓN OCULTO

In contrast to the visible system, this hidden and longitudinal chemical mechanical system uses steel clips which are inserted into the grooves previously made in the ceramic edges.

A diferencia del visible en este sistema de mecánica química oculta y longitudinal se usan clips de acero que se insertan en las ranuras previamente realizadas en los bordes cerámicos.

Espesor: 8,5 mm - 14 mm de espesor - 8,5 mm to 14 mm thickness.

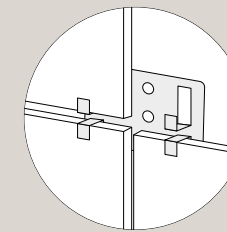

(cat.3+visto)

VISIBLE FASTENING SYSTEM.

SISTEMA FIJACIÓN VISTO

A diferencia del visible en este sistema de mecánica química oculta y longitudinal se usan clips de acero que se insertan en las ranuras previamente realizadas en los bordes cerámicos.

Espesor: 6 mm - 8,5 mm de espesor 6 mm to 8,5 mm thickness. 8,5 mm - 14 mm de espesor - 8,5 mm to 14 mm thickness.



PORCELAIN
FLOOR TILE
WALL TILE
RECTIFIED
MATT
RELIEF

PORCELÁNICO
PAVIMENTO
REVESTIMIENTO
RECTIFICADO
MATE
RELIEVE

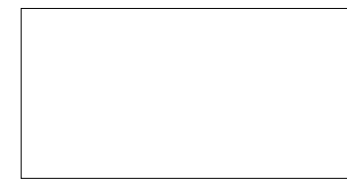

75x150 | 30"x60"



25x150 | 10"x60"

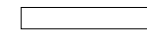

10x60 | 4"x24"

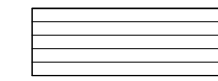

30x90 | 12"x36"



30x30 | 12"x12"



30x30 | 12"x12"



30x30 | 12"x12"

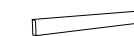

RODAPIÉ | SKIRTING
7,5x75 cm | 3"x30"
PZRod775



PELDAÑO ROMO | ROUND STEP
37x150 cm | 15"x60"
PZPeld37150Romo



PELDAÑO L | STEP L
37x150 cm | 15"x60"
PZPeld37150

		Caja Box		Palet Pallet		Container		Container	
		Piezas Tiles	M ²	Kg.	Cajas Boxes	M ²	Kg.	M ²	M ²
COUVET STONE									
75x150 30"x60"	MPRec75150	1	1,125	24,04	42	47,25	1.009,68	992,25	1.134,00
COUVET PETRA									
75x150 30"x60"	MPRec75150	1	1,125	24,04	42	47,25	1.009,68	992,25	1.134,00
COUVET TRAVERTINO									
75x150 30"x60"	MPRec75150	1	1,125	24,04	42	47,25	1.009,68	992,25	1.134,00
COUVET MARBLE									
75x150 30"x60"	MPRec75150	1	1,125	24,04	42	47,25	1.009,68	992,25	1.134,00
COUVET FACADE									
75x150 30"x60"	MPRec75150	1	1,125	24,04	42	47,25	1.009,68	992,25	1.134,00
COUVET WOOD									
75x150 30"x60"	MPRec75150	1	1,125	24,04	42	47,25	1.009,68	992,25	1.134,00
25x150 10"x60"	MPRec25150	3	1,125	24,56	54	60,75	1.326,24	972,00	1.093,50
10x60 4"x24"	MPI060	18	1,08	21,43	56	60,48	1.200,08	1.088,64	1.209,60
30x90 12"x36"	Listón MWRRec3090	4	1,08	21,20	63	68,04	1.335,60	1.088,64	1.224,72
MALLA / MURETO / LOSANGA									
30x30 12"x12"	MPRec3030	7	0,60	11	54	32,40	594	-	-

promotion

EXPOSITOR COUVET COLLECTION
18 Piezas

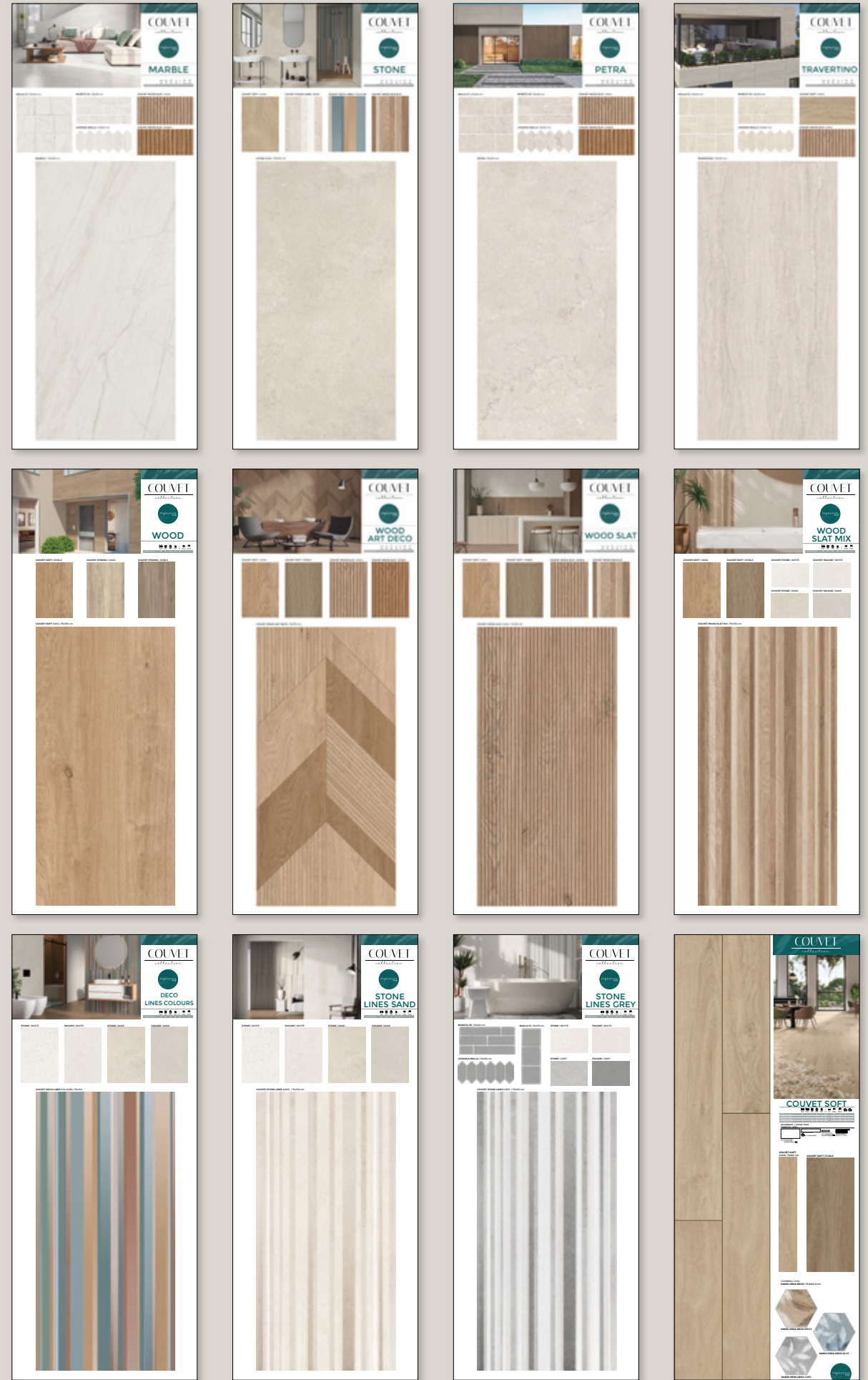
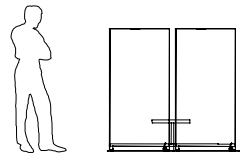

mykonos

Pol. Ind. El Colomer
Calle Melilla, 1
12200 ONDA. Castellón. Spain

T. +34 964 914 091
F. +34 964 106 008
www.mykonosceramica.com

COUVET

collection



DESCÁRGATE NUESTROS CATÁLOGOS
DOWNLOAD OUR CATALOGS



VISITA NUESTRAS REDES SOCIALES
VISIT OUR SOCIAL NETWORKS

2023 | SEPTEMBER